



BOTTLE-TO-BOTTLE

Technologies

- VACUNITE®
- VACUREMA®
- VACUREMA® Inline Preform

CHOOSE THE NUMBER ONE.

A SAFE CHOICE.

Bottle-to-bottle solutions
from EREMA.

Because it's about your brand.

Clean melt, clean recycled pellets, clean preforms. EREMA bottle-to-bottle systems stand for uncompromising food contact compliance, highly efficient decontamination, high-performance filtration and safe handling. For top-quality end products.



BRAND OWNER
APPROVED

It's so easy.

Stable processes and consistently high quality pellets and preforms: Production and plant managers appreciate these characteristics of VACUNITE® and VACUREMA® systems. Simple operation and a high degree of automation included. The fact that the end product remains stable even if the input material parameters change is a clear flexibility bonus. Safe and proven - around 400 VACUREMA® systems are in use worldwide.

A reliable investment.

The best decision is a safe decision. EREMA bottle-to-bottle systems offer impressively low total cost of ownership, low energy consumption and high uptime. Fully in keeping with high productivity, cost effectiveness and efficiency. And that you can safely rely on.



ADVANTAGES



Superclean rPET pellets



For direct food contact with IV value on a par with virgin material



Flexible input, consistent output
consistent end products in terms of IV value and colour despite varying moisture, IV values, bulk densities and flake wall thicknesses of the input material



Maximum resource efficiency
technology saves energy, water and space



Easy to operate
high degree of automation



Safe and proven 100 times over



SafeFlake

Reliable decontamination of the flakes.

The central advantage of VACUNITE® and VACUREMA® systems is the unique SafeFlake technology in the vacuum reactor, which unites several central functions in one - in particular flake decontamination, drying and IV treatment.

By pre-treating the PET flakes in a vacuum at the correct temperature - and, in the case of VACUNITE®, with the additional application of nitrogen - moisture and migratory substances are removed effectively as part of the process before extrusion. This prevents any hydrolytic and oxidative decomposition of the melt in the extruder. A clear advantages in terms of melt quality and therefore the basis for a stable, highly clean and food-compliant end product with the best colour values.



SafeFlake decontamination ensures reliable removal of migration substances and moisture as well as IV treatment of the PET flakes BEFORE extrusion



Better melt quality, better end product quality



Compensates for different moisture and IV values in the input material - for more flexibility.

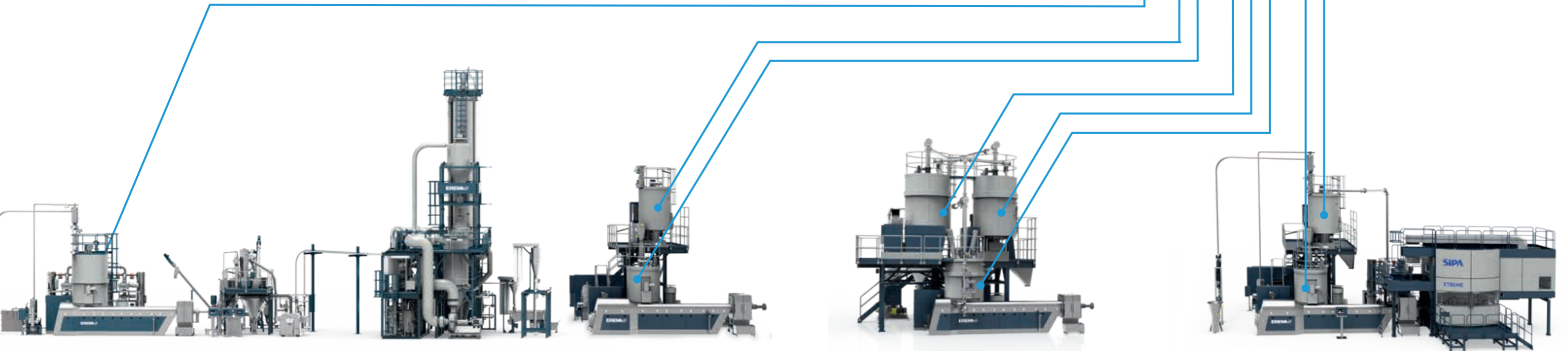

VACUNITE®

VACUREMA® Advanced

VACUREMA® Prime

VACUREMA® Inline Preform



Save costs thanks to energy efficiency.

Electricity accounts for around one third of the costs of bottle-to-bottle recycling. Technologies that use energy economically therefore have a clear advantage. EREMA sets the standard here with top energy efficiency for VACUREMA® Prime, which undercuts the magic threshold of 0.30 kWh/kg specific total energy consumption. And only 0.35 kWh/kg consumption for VACUNITE® - from flake to finished rPET pellets, including SSP. **That is energy efficiency that really pays off. Hour after hour.**



Top energy efficiency

- Energy-saving SafeFlake vacuum pretreatment: decontamination, drying and IV treatment of flakes in one step
- SafeFlake pre-treatment makes it possible to use a short extruder, without additional degassing
- Saves production costs
- Lowers the Total Cost of Ownership (TCO)
- Saves resources and reduces CO₂ emissions

Consistent output despite input fluctuations.

Thanks to SafeFlake's vacuum technology, the system achieves the required IV values and maintains them at a stable level - even though the input material has mixtures of different IV values and wall thickness as well as varying humidity. The intrinsic viscosity (IV) is so stable here that the values even lie within the tolerance limits for virgin PET material. **For constant quality and high product safety.**



Uncompromising stability: IV free from fluctuations

- The IV value achieved remains stable
- IV values the same as virgin material
- Decisive quality advantage for further processing into preforms and for subsequent stretch blow moulding
- High product safety
- Equipped for the future: up to 100 % rPET in new bottles

Built for 24/7.

Supported with valuable feedback from EREMA customers, our engineers and product developers have come up with some ingenious solutions to make the processes used in VACUNITE® and VACUREMA® systems simple, safe and efficient. This is proven by numerous patents that make it possible to achieve high throughput in a very direct way - without detours. The philosophy is: "Fewer components, but they must be high-quality with a robust design," **for more safety, less maintenance and higher overall equipment availability.**



Ingenious design. Robust components.

- Durable components
- Maximum system availability
- Less maintenance
- Enhanced safety

* EREMA bottle-to-bottle technologies consume up to 36% less energy (kWh/kg) than systems from other suppliers



VACUNITE[®]

Unites vacuum and nitrogen technology



VACUNITE®

For the highest requirements. Impressive energy-efficient brand owner quality.

VACUNITE® redefines the benchmark for performance in bottle-to-bottle recycling: Uncompromising safety, productivity and quality are ensured thanks to the highest decontamination efficiency, rPET granulates with the best colour values, top IV stability, compactness of the system as well as low energy consumption throughout the entire process.

Your combination for safety: Improved VACUREMA® + Polymetrix SSP



This is made possible by the unique combination of two technologies: VACUNITE® unites VACUREMA® technology, which has been tried and tested for decades and has been further developed especially for this application - together with newly patented vacuum-assisted V-LeaN Solid State Polycondensation (SSP), which was also specially developed by Polymetrix (the manufacturer) for EREMA for this demanding application. Key quality and safety advantage: **All thermal process steps take place in nitrogen and/or vacuum atmosphere.**

VACUNITE®

- Unites vacuum & nitrogen technology
- For the highest rPET purity & enhanced safety



ADVANTAGES

 **Highly efficient decontamination, minimal VOC content, AA level < 1 ppm = Brand Owner Approved**

 **Higher rPET content is possible in the end product thanks to the best rPET colour values = fit for the future**

 **Very energy-saving: Only 0.35 kWh/kg specific energy consumption**
(All-in: including all auxiliary units such as the chiller for cooling water treatment, at 1,000 kg/h)

 **Around 40 % fewer components**

Equipped for the future: Better output despite poorer input

In order to be approved for contact with food, recycled PET plastics must meet increasingly stringent quality criteria. At the same time, the demand for high-quality recycled pellets on the market is increasing because legal requirements and voluntary commitments of leading brand manufacturers demand a higher use of recyclates in the end products. Although overall this increases the collection rate, it also leads to poorer quality input materials for recycling because the proportion of inhomogeneous components in the material flow also increases. This means that recycling plants today, and in the future, have to produce better quality output material with poorer quality input material.

Thanks to the intelligent combination of technology, VACUNITE® excels at this new challenge with flying colours.

KEY BENEFITS

- ~ 40 % fewer components required*
-> less energy, lower costs
- 36 % less energy needed*
-> lower costs, better environment
- Proven technologies developed for VACUNITE®
- More safety and quality
All thermal processes are in nitrogen and/or vacuum atmosphere

THE ADVANTAGES OF VACUREMA® TECHNOLOGY

-  **Highly efficient decontamination thanks to SafeFlake BEFORE extrusion**
-  **Flexible with input** even when moisture, IV values, bulk densities & flake wall thicknesses vary ...
-  **Stable output**
... IV value and colour remain constant
-  **Up to 40 % less dwell time in the extruder*)** less thermal stress, better colour values, less energy, lower costs
-  More efficient for the **best colour values** thanks to vacuum & nitrogen flushing
-  **No additional post-crystallisation** needed

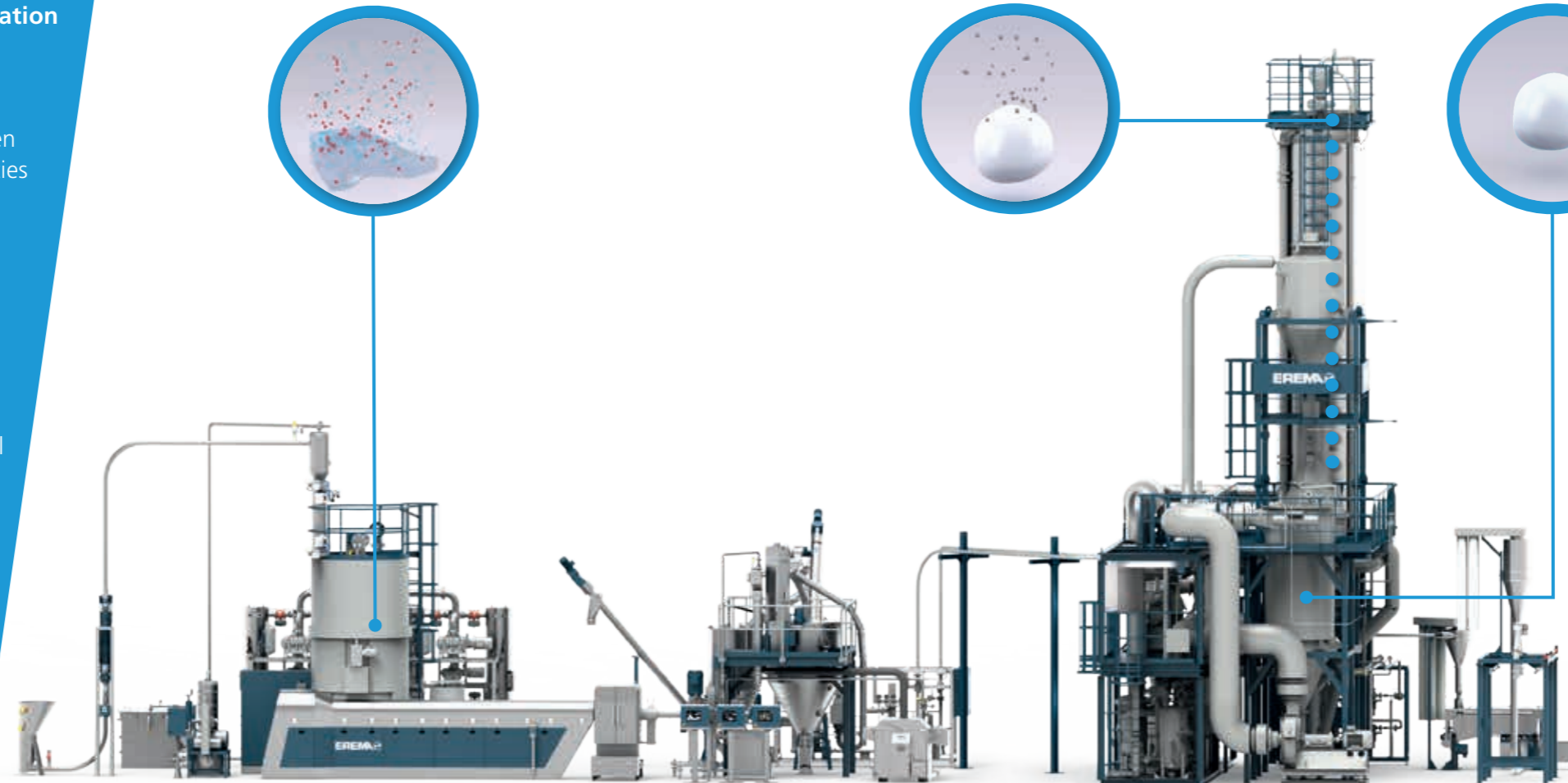

VACUREMA®
Technology with nitrogen

Vacuum assisted **solid state polycondensation (V-LeaN SSP)** in nitrogen



* EREMA bottle-to-bottle technologies consume at least 36% less energy (kWh/kg) than systems from other suppliers



THE ADVANTAGES OF V-LEAN SSP

-  **1 First in - First out**
-  **Highly efficient decontamination**
-  **N2 Hardly any yellowing** thanks to controlled pellet heating in nitrogen atmosphere in the preheater
-  **Excellent preform clarity**
-  **New:** units are pre-assembled on skids to save costs and reduce installation and commissioning times

VACUNITE®

How it works.

The key components of the system include a vacuum reactor with integrated nitrogen flushing which is connected directly to a single-screw extruder. Thanks to the ingenious function of the mixers in the vacuum reactor they feature three ultra-efficient function zones which interact perfectly with each other to decontaminate and predry the PET material BEFORE extrusion. The dwell time in the reactor is between one-and-a-half and two hours, depending on the throughput.

ZONE 1:

Removing the external moisture from the PET flakes

The amorphous, washed flakes which enter Zone 1 via a vacuum sluice, still have extremely varying external moisture to begin with (between 0.5 and 1%). This is eliminated at around 20°C under vacuum through the reduced vaporisation point (the inner moisture here is still constant at around 0.3%).

Special VACUNITE feature: nitrogen flushing

In the VACUNITE system, the sluice is also flushed with nitrogen (N₂). The advantage is that this significantly reduces the residual oxygen content that is responsible for irreversible yellow colouration.

ZONE 2:

Temperature rise from 20° C to 190° C

Thanks to the constantly rising temperature, the polymer structure opens up and the process for the removal of the migration substances and the internal moisture from the flakes begins. This dehumidification stage reduces IV loss.

ZONE 3:

The process of flake decontamination and removal process unfolds with full effect.

The material moves layer by layer in the direction of the single-screw extruder during the exactly defined residence time. With very low residual moisture of under 0.05% the clean, ideally prepared material enters the intake zone of the extruder.

This material transfer takes place under high vacuum. As a result, no additional degassing ports are required on the extruder itself. This means that the technology drastically reduces the length of the extruder, reduces its energy consumption, improves the colour values (b value) of the processed material and keeps AA values to a very low level. Moreover, the strong homogenisation performance of the extruder plays a significant part in turning the different input IV values into a stable output IV value.

In addition to decontamination and drying, the bulk density increase inside the reactor is up to 100 % and the flakes are crystallised. This allows the extruder to be fed in a constant flow, which is an essential prerequisite for consistent throughput rates.

Clean PET melt

Thanks to the efficient ultra-fine filtration, the smallest of contaminants such as aluminium and steel particles are removed from the PET melt highly effectively and in a material-friendly way. The very large active filtration area, compared to other filters, lowers the pressure in the extruder to prevent solid contaminants being forced through the filtration medium. The filter system is equipped with a patented fully automatic self-cleaning system that enables long filter service life and minimises the risk of black spots.

Underwater pelletiser for inline crystallisation

The filtered PET melt is then cut in hot water and transported a short distance to the centrifuge, where the pellets are crystallised by latent heat crystallisation from the inside to the outside without the need for an external source of energy. The special configuration of this process and the temperature control of the VACUNITE® process enables very high crystallisation rates (>40%) without having to install an additional post-crystallisation process. This is a decisive advantage in terms of the number of components and energy efficiency, because overall the VACUNITE® concept requires around 40% fewer components and thus up to 36% less energy than comparable systems on the market.



Patented vacuum assisted nitrogen solid state polycondensation (V-LeaN SSP)

The food-grade, spherical and crystalline pellets obtained in this way are fed to the nitrogen SSP in a hot state. This patented system was developed exclusively for EREMA by Polymetrix and has the following special features:

The pellets from inline crystallisation are blown into a buffer vessel via a pressure transport system. There, a rotary valve separates the ambient atmosphere from the nitrogen environment. In order to counteract discolouration at elevated temperatures, the pellets are then brought up to process temperature in a preheater with nitrogen and fed into the SSP. There a separation between normal pressure and negative pressure takes place again, so that a vacuum-assisted nitrogen atmosphere can be guaranteed. The vacuum is generated by water ring pumps without additional mechanical boosters, as in this case a moderate vacuum is sufficient due to the dry material. In addition, the SSP is flushed with fresh nitrogen. The combination of vacuum, the right nitrogen flow rate, temperature, dwell time and very narrow dwell time spectrum enables defined process control and results in unique decontamination performance.

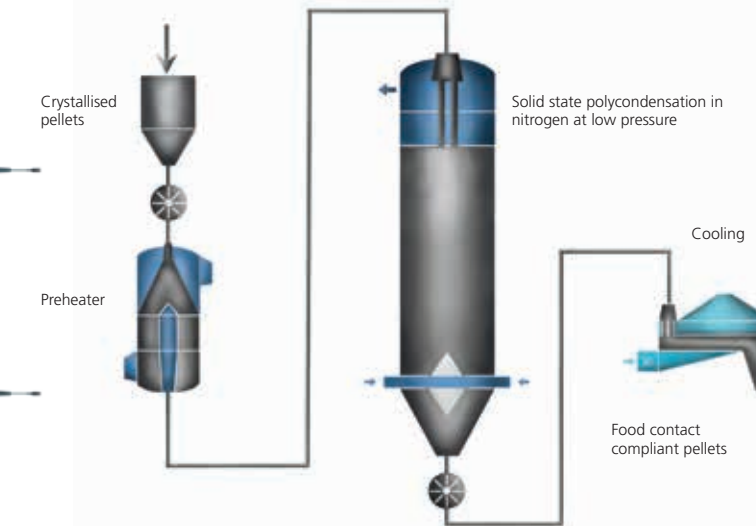

The nitrogen is injected into the SSP by means of a contraflow process. On its way to the top, it absorbs contaminants, glycol and other by-products from the IV increase process. In the subsequent water ring pump system, the nitrogen is purified again so that it can be returned to the upstream process steps. In addition, the viscosity in the SSP is raised again to values suitable for preform production.

In a final process step, the pellets are finally cooled in a fluidised bed and de-dusted in parallel to increase the transparency of the preforms. The same cooling can also be used for the VACUREMA® basic system, i.e. an operating mode without IV increase and without SSP e.g. for sheet or fibre applications is possible.

As an end product, the new VACUNITE® technology produces rPET pellets of unique quality which, in terms of food contact compliance, significantly exceed both the current legal requirements and the even higher requirements of leading brand owners.

VACUNITE®	System throughput	Reference-IV-performance*	Total energy consumption** (0.35 kWh/kg)	Nitrogen consumption	Flake reactor vacuum	Flake reactor performance	Extruder	Pellet form	SSP powered by POLYMETRIX	Final pellet quality	Space needed	Height / SSP height
Model	Maximum [kg/h]	[dl/g @ kg/h]	[kWh/h]	[Nm³/kg]	[mbar]	Advantages	L/D drive-rating [kW]	Granumetry	Type	AA Level VOCs	[m²]	[m / m]
VACUNITE® 1714 T - 1000 M	-1250	0.82 @ 1000	350	0.085	< 10 redundant filter	Residual moisture < 50ppm several national and international approvals	~ 27 160 kW	spherical inline crystallised	FIFO vacuum supported N ₂ SSP	<1 ppm brand owner OK	270	5.5 / 14
VACUNITE® 1716 T - 1500 M	-1500	0.82 @ 1300	455	0.085	< 10 redundant filter		~ 27 200 kW	spherical inline crystallised	FIFO vacuum supported N ₂ SSP	<1 ppm brand owner OK	320	6.5 / 16
VACUNITE® 2018 T - 1500 M	-1875	0.82 @ 1550	543	0.085	< 10 redundant filter		~ 27 315 kW	spherical inline crystallised	FIFO vacuum supported N ₂ SSP	<1 ppm brand owner OK	380	7.5 / 16
VACUNITE® 2318 T - 1500 M	-1875	0.82 @ 1800	630	0.085	< 10 redundant filter		~ 27 315 kW	spherical inline crystallised	FIFO vacuum supported N ₂ SSP	<1 ppm brand owner OK	380	7.0 / 16
VACUNITE® 2321 T - 2000 M***	-2300	0.82 @ 2100	735	0.085	< 10 redundant filter		~ 27 355 kW	spherical inline crystallised	FIFO vacuum supported N ₂ SSP	<1 ppm brand owner OK	400	7.0 / 16
VACUNITE® 2621 T - 2000	-2500	0.82 @ 2350	823	0.085	< 10 redundant filter		~ 27 400 kW	spherical inline crystallised	FIFO vacuum supported N ₂ SSP	<1 ppm brand owner OK	480	9.0 / 14

* At an input flake IV of 0.76 dl/g
 ** including expected power consumption of necessary water chillers at the customer's plant
 *** available from 2023
 Subject to latest technical updates.



VACUREMA®



VACUREMA®

Compact TCO champion. The benchmark in saving energy. Maximum flexibility.

Highly efficient decontamination, safe, stable and fast results. With VACUREMA® technology, you can rely on an efficient and extremely cost effective system that compactly unites all the necessary bottle-to-bottle process steps. Uncompromising food contact compliance, impressively low

total cost of ownership (TCO) and strong advantages in terms of flexibility are the cornerstones of the success of this system, which has been proven several hundred times and is continuously updated with the latest technology.



ADVANTAGES



Fast and flexible

The final IV value is achieved before granulation - so it is possible to change products from one defined pellet quality to another very quickly



VACUREMA® Prime.

The benchmark in saving energy.

Extreme energy efficiency: Only 0.35 kWh/kg specific energy consumption (All-in: including all auxiliary units such as the chiller for cooling water treatment, at 1,000 kg/h)



TCO champion

Low total cost of ownership (TCO) - a complete, efficient, energy-saving system that combines all the necessary bottle-to-bottle process steps into one compact process.



TCO
Champion

VACUREMA® stands out with particularly attractive **Total Cost of Ownership.**

- High energy-efficiency
- No nitrogen
- Minimum maintenance costs
- Small footprint and workshop height

Traceability Champion

What you see is what you get

Final pellet quality values (incl. IV value) are already achieved before pelletising.



0.295 kWh/kg.

VACUREMA® Prime - the benchmark in saving energy.
Specific total energy consumption kWh/kg

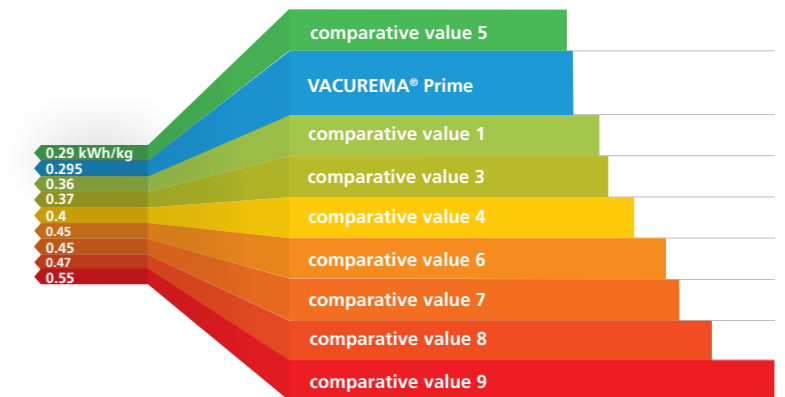

Only 0.295 kWh/kg – this is how low the specific total energy consumption of the VACUREMA® Prime bottle-to-bottle system is. This outstanding figure regarding energy efficiency was achieved in impressive style by the EREMA system in an independent comparison with eight other PET processing lines.

Source: SKZ – Das Kunststoff-Zentrum, value measured excluding customer's chiller for supplying cooling water at a throughput of 1,650 kg/h.



VACUREMA® ADVANCED & PRIME







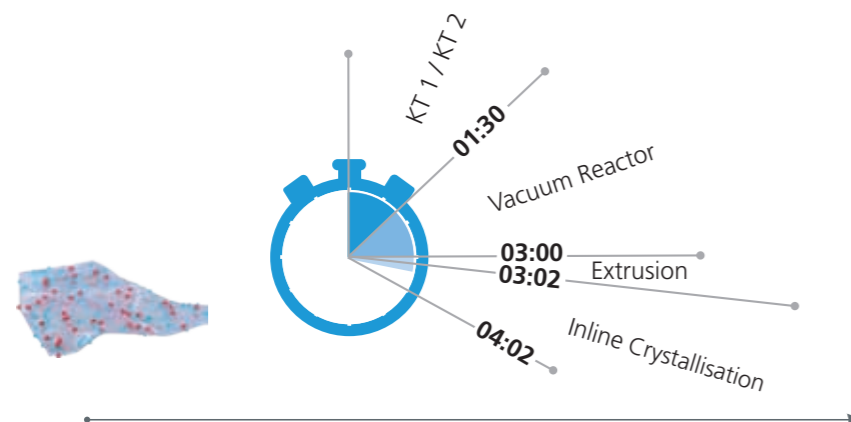
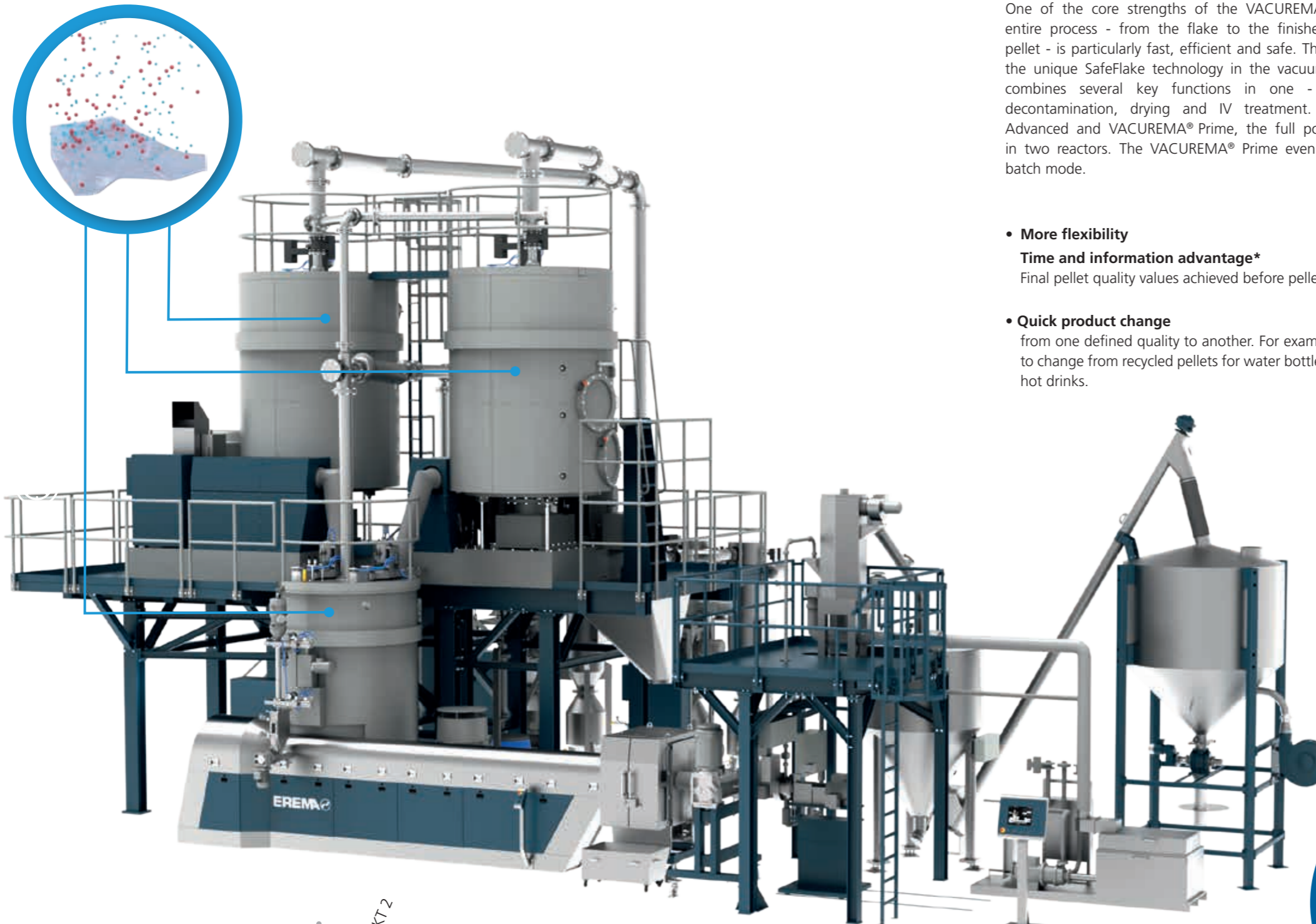

Short processing time = quick and reliable results.
Thanks to the multiple potentials of SafeFlake.

One of the core strengths of the VACUREMA® system is that the entire process - from the flake to the finished, food contact rPET pellet - is particularly fast, efficient and safe. This is made possible by the unique SafeFlake technology in the vacuum reactor, because it combines several key functions in one - in particular flake decontamination, drying and IV treatment. With VACUREMA® Advanced and VACUREMA® Prime, the full potential is unleashed in two reactors. The VACUREMA® Prime even operates in proper batch mode.

- **More flexibility**
Time and information advantage*
Final pellet quality values achieved before pelletising.
- **Quick product change**
from one defined quality to another. For example, if you want to change from recycled pellets for water bottles to bottles for hot drinks.



ADVANTAGES

-  **Highly effective decontamination**
BEFORE extrusion
-  **Up to 40 % less dwell time in the extruder***
Less thermal stress, better colour values, less energy, lower costs
-  **Flexible with input**
Even when moisture, IV values, bulk densities & flake wall thickness vary ...
-  **Stable output**
... IV value and colour remain constant
-  **36 % less energy needed***
- lower costs, better for the environment
-  **No additional post-crystallisation needed**
-  **High flexibility** for quick product changes
-  **Final IV before pelletising**
Fast, safe overall process (thereby 100 % online IV control)

**TECHNICAL
ADVANTAGES
AND ECONOMIC**

* compared with other systems on the market from alternative suppliers



VACUREMA® PRIME

How it works.

Two parallel vacuum crystallisation dryers are filled with amorphous, washed PET flakes. The crystallisation dryers work in **proper batch mode**. **The exceptionally high level of purity of the rPET** that is produced is achieved by an exactly defined and guaranteed minimum treatment time for every single thin-walled PET flake in vacuum and at increased temperature. The decontamination requirements specified by authorities and brand owners are fulfilled through the adjustable batch times.

The two identical crystallisation dryers are situated immediately upstream of the **continuously** operating vacuum reactor. **The IV increase of the PET flakes takes place inside the reactor** through solid-phase polycondensation which takes it to the required level. The material is melted under vacuum in the directly connected extrusion system.

The benefits of the VACUREMA® extruder: robust single screw technology and compact design for minimum thermal material stress.

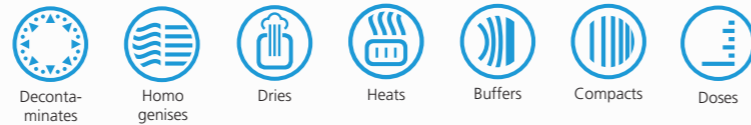

1 Highly efficient PET flake batch decontamination
The patented pretreatment at elevated temperature and under vacuum before the extrusion process removes moisture and migration materials from the feedstock very effectively and in a stable process environment. This prevents any hydrolytic and oxidative decomposition of the melt in the extruder.

2 IV increase
IV value is raised to the required level.

3 Melting under vacuum

4 Low thermal stress
The very short extruder screw without additional extruder degassing reduces the thermal stress on the material through minimised dwell time.

5 Large-area ultrafine melt filtration
The robust, fully automatic filter removes even the smallest of aluminium, steel and other particles from the melt. The very large active filter areas enable filtration with up to 32 µm fineness with a low pressure level. The result is highly clean pellets.

6 Underwater pelletiser for inline crystallisation
The PET melt is cut in hot water and transported to the centrifuge, where the pellets are crystallised by latent heat crystallisation from the inside to the outside without the need for an external source of energy. The configuration and temperature control used for this process enables very high crystallisation rates (>40%) without an additional post-crystallisation process. The advantage: fewer components, less consumption.

VACUREMA® PRIME Technical data.

VACUREMA® PRIME	System throughput maximum [kg/h]	Reference-IV-performance* [dl/g @ kg/h]	Total energy consumption** (0.35 kWh/kg)	System process duration Total [h]	Flake reactor vacuum Advantages [mbar]	Flake reactor performance Residual moisture	Extruder drive-rating [kW]	LD	Pellet form	Final pellet quality AA level VOCs	Space needed [m²]	Height / KT height [m / m]
VACUREMA® PRIME 1310 T	-600	0.82 @ 500	175	3h	≤ 5 redundant filter	Residual moisture < 50ppm several national and international approvals	~ 27 75 kW	~ 27	spherical or cylindrical inline crystallised	< 2 - 4 ppm < 1 ppm with OPTIONAL Pellet Flusher brand owner status depending on setup	285	6.0 / 9.0
VACUREMA® PRIME 1512 T	-900	0.82 @ 700	245	3h	≤ 5 redundant filter		~ 27 110 kW	~ 27	spherical or cylindrical inline crystallised		295	6.0 / 9.5
VACUREMA® PRIME 1714 T	-1000	0.82 @ 850	298	3h	≤ 5 redundant filter		~ 27 160 kW	~ 27	spherical or cylindrical inline crystallised		320	6.0 / 10.0
VACUREMA® PRIME 1716 T	-1500	0.82 @ 1250	438	3h	≤ 5 redundant filter		~ 27 200 kW	~ 27	spherical or cylindrical inline crystallised		330	6.0 / 10.5
VACUREMA® PRIME 2018 T	-2000	0.82 @ 1500	525	3h	≤ 5 redundant filter		~ 27 315 kW	~ 27	spherical or cylindrical inline crystallised		360	6.0 / 11.0
VACUREMA® PRIME 2318 T	-2050	0.82 @ 2000	700	3h	≤ 5 redundant filter		~ 27 315 kW	~ 27	spherical or cylindrical inline crystallised		400	6.0 / 11.0
VACUREMA® PRIME 2021 T	-2350	0.82 @ 1850	648	3h	≤ 5 redundant filter		~ 27 315 kW	~ 27	spherical or cylindrical inline crystallised		385	6.0 / 11.5
VACUREMA® PRIME 2321 T	-2600	0.82 @ 2300	805	3h	≤ 5 redundant filter		~ 27 400 kW	~ 27	spherical or cylindrical inline crystallised		410	6.0 / 12.5
VACUREMA® PRIME 2621 T	-3000	0.82 @ 2750	963	3h	≤ 5 redundant filter		~ 27 400 kW	~ 27	spherical or cylindrical inline crystallised		475	6.0 / 12.0
VACUREMA® PRIME 2625 T	-3600	0.82 @ 3000	1050	3h	≤ 5 redundant filter		~ 27 500 kW	~ 27	spherical or cylindrical inline crystallised		495	6.0 / 12
VACUREMA® PRIME 2628 T	-4700	0.82 @ 3500	1225	3h	≤ 5 redundant filter		~ 27 560 kW	~ 27	spherical or cylindrical inline crystallised		530	6.0 / 11.5

* At an input flake IV of 0.76 dl/g
** including expected power consumption of necessary water chillers at the customer's plant
Subject to latest technical updates.



VACUREMA[®] INLINE PREFORM



VACUREMA® INLINE PREFORM

The direct route from flake to preform.

Fast, efficient, safe and extremely energy-saving: Innovative VACUREMA® Inline Preform Technology converts post consumer PET flakes – directly from the melt – into food contact compliant preforms in one continuous process step. These can consist of up to 100% rPET and achieve impressive colour values - there is hardly any yellowing.

They save the detour of pellet production to deliver a series of advantages: Big savings in energy consumption, fewer machine components and therefore reduced TCO as well as significantly less space, logistics and processing costs. For more cost-effectiveness in your preform production.

The system unites the efficiency benefits of proven VACUREMA® technology with SIPA's innovative XTREME preform production system. By combining injection and compression techniques this system allows you to produce preforms that are up to 10% lighter than even the lightest injection moulded preforms. And this is possible without losing any key characteristics.



SIPA
Cooperation partner



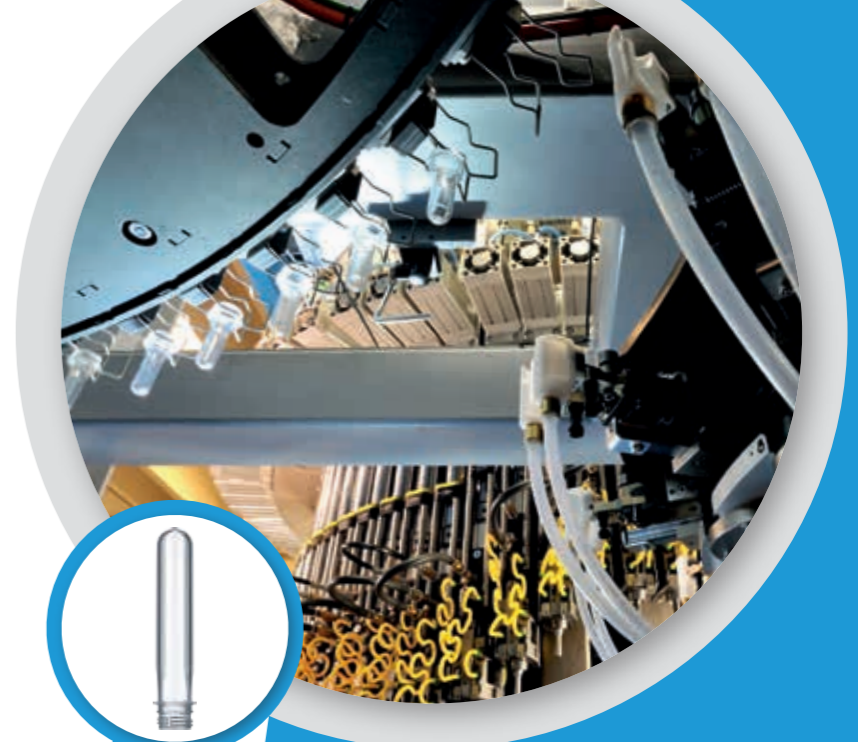

Number of cavities	Flakes	Max. number of preforms / hour	Min. wall thickness of preform base (mm)	Max. preform weight (g)	Max. preform length (mm)
96	100 %	70,000	0.95	60	150
72	100 %	57,600	0.95	60	150



Direct inline processing to make PET bottles possible







ADVANTAGES

-  **SafeFlake:**
Highly efficient decontamination
-  The system for 100 % rPET content in the preform = **fit for the future**
-  **The system** for extremely light bottles
-  **Safe, fast, flexible - from flake to finished preform in the shortest possible process time:** This makes the fastest product changes possible.





VACUREMA® INLINE PREFORM

ONLY
0.58 kWh/kg
energy consumption
FROM FLAKE TO PREFORM

KEY BENEFITS

-  **Up to 30 % lower energy consumption¹** A continuous thermal cycle from flake to preform
-  **Up to 60 % lower CO₂ emissions²**
-  **Significantly fewer machine components** therefore better TCO (Total Cost of Ownership)
-  **Lower logistics, process and transport costs**

Innovative inline processing **saves the "detour"** of pellet production

-  **Time and information advantage³** Final IV value already known at the injection compression machine
-  **Fast product changes** from one defined quality to another, e.g. if you want to change from preforms for water bottles to those for CSD bottles.
-  **Top preform quality** with ideal mechanical properties for the stretch blow process⁵
-  **Top colour values** with hardly any yellowing⁵
-  **Up to 100 % rPET content** Save on virgin materials, save CO₂, fit for the future with the circular economy

THE ADVANTAGES OF VACUREMA® TECHNOLOGY

-  **Flexible with input**
Even when moisture, IV values, bulk densities & flake wall thickness vary ...
-  **Stable output**
... IV value and colour remain constant
-  **Highly effective decontamination**
BEFORE extrusion
-  **Up to 40 % less dwell time in the extruder⁴**
Less thermal stress, better colour values, less energy, lower costs



TECHNICAL
ADVANTAGES
AND ECONOMIC

THE ADVANTAGES OF THE SIPA XTREME RENEW SYSTEM

rotary injection moulding process

-  **Low mould wear** due to low clamping force (max. 2 tonnes)
-  **Gentle material treatment** thanks to very low injection pressure
-  **100% inline quality control of preforms** possible
-  **Up to 10 % lighter PET containers⁵** less material, lower costs
-  **Simultaneous production of two different bottle designs** possible

From flake to finished preform
in the shortest possible process time!

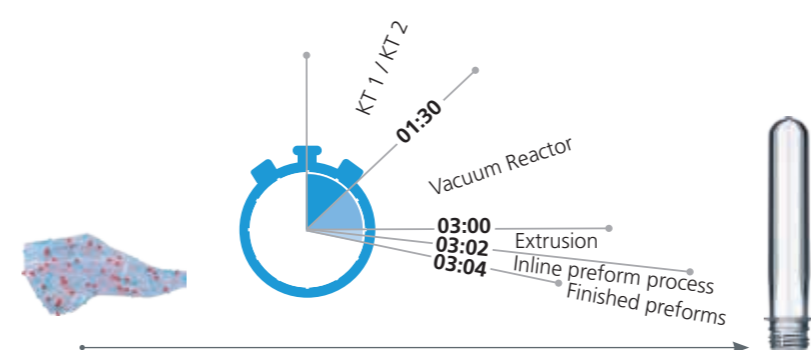

1 Compared to conventional multi-stage systems for rPET recycling and preform production
2 compared to PET process with virgin material
3 In contrast to alternative technologies, where the final IV value is only achieved after the pellet SSP, VACUREMA® technology provides very early confirmation that "everything is OK"
4 Compared to other comparable systems on the market
5 Compared to PET preforms produced used conventional injection moulding



Food Contact Control (FCC)

Process safety and traceability

Thanks to the automatic Food Contact Control (FCC) operating mode, the parameters for direct food contact compliance are monitored and saved continuously throughout the recycling process. If levels are not kept, an alarm is triggered automatically so that material flow can be diverted away from the production line. Data traceability is also guaranteed thanks to archiving with FCC. The result is a reliable process at all times.

Food contact compliant with VACUREMA®

Technology well within the strict EFSA limits

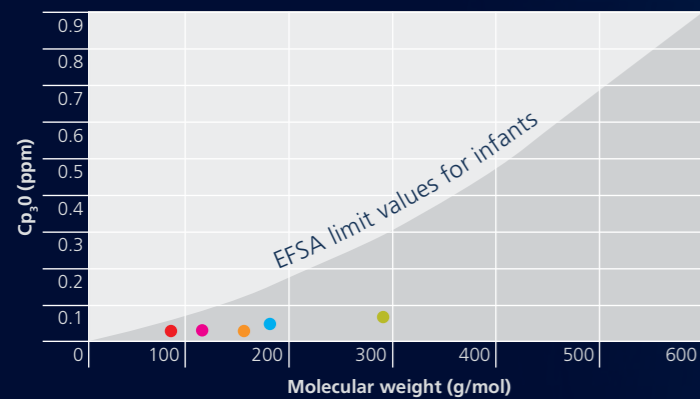

Test values with VACUREMA® technology

- Toluol
- Benzophenone
- Chloroform
- Lindane
- Phenylcyclohexane

QualityOn:IV

IV measurement directly at the system

Thanks to the practical QualityOn:IV viscometer, you are informed about the current IV value at all times during the ongoing process. This continuous online IV measurement, enabled by the fully automatic control system, allows you to optimise a number of important processing parameters such as throughput, processing temperatures, filling levels, etc.

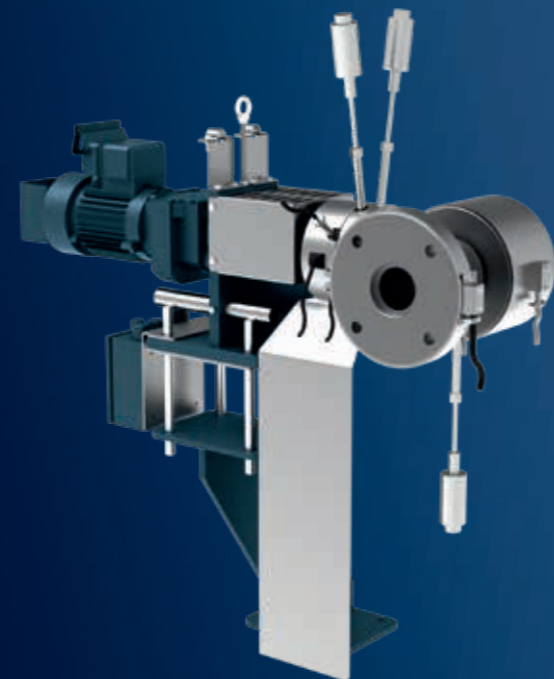

Smart Service Package

Modern connectivity solutions

With the EREMA Smart Service Package, you have the benefit of state-of-the-art connectivity solutions. These include practical remote access services, such as remote maintenance, and BluPort, the new digital EREMA Performance Platform. These services provide intelligent solutions and apps for improved machine performance and equipment availability, quick and easy spare parts service and straightforward maintenance.

BluPort®
PERFORMANCE PLATFORM

Recipe management

The right recipe for every application

Do you want to change your recipe during operation? The practical recipe management system allows you to handle such product changeovers remarkably easily and quickly: simply press a button and you have all the saved process parameters of the new recycled pellets and can start with production.

Headquarters & Production Facilities

EREMA Engineering Recycling
Maschinen und Anlagen Ges.m.b.H.
Unterfeldstrasse 3 / 4052 Ansfelden / Austria
Phone: +43 (0)732/31 90-0
erema@erema.at / www.erema.com

**For worldwide subsidiaries and
representatives please visit
www.erema.com**

Subject to technical modifications.
© EREMA Engineering Recycling Maschinen
und Anlagen Ges.m.b.H.



02/24

[https://www.erema.com/en/
download_center/](https://www.erema.com/en/download_center/)